

RoHS2.0
Compliant

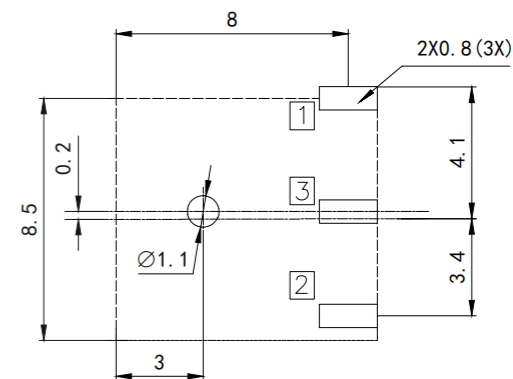

RECOMMENDED P. C. B LAYOUT
UNSPECIFIED TOLERANCE: ±0.05

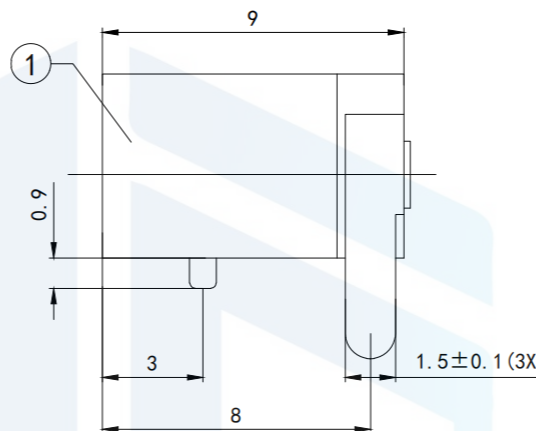
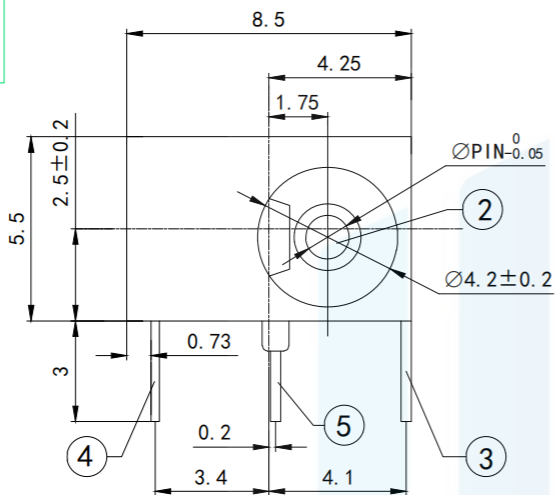
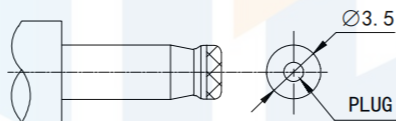
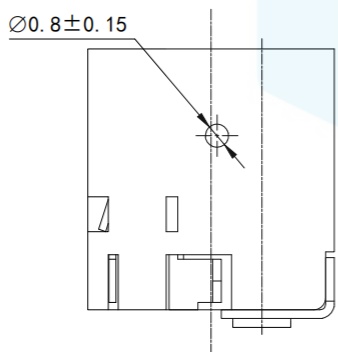

DC MATE PLUG

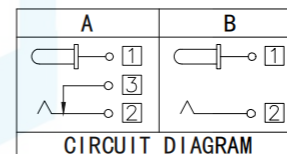

Model NO	C	E
CENTER PIN	Ø1.0	Ø1.3
PLUG O. D	Ø1.05 ^{+0.1} ₀	Ø1.35 ^{+0.1} ₀

Technical requirements
Use conditions: -40~55° C
Rated load: DC 30V 0.5A
Contact resistance: ≤0.03 Ω
Insulation resistance: ≥100 Ω DC250V
Withstand voltage: AC 500V (50Hz)/min
Insertion force: 3~20N
Mechanical life: 5000 times

TOLERANCE

X. XXX	±0.05
X. XX	±0.15
X. X	±0.20
X.	±0.30
ANGLE	±5.0°

PROTECTON

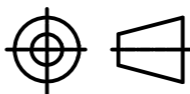

东莞市恒祺电子科技有限公司

Dongguan Hengqi Electronic Technology Co., Ltd

<https://www.hq-dz.com>

phone:15812872448

TITLE:

DC电源插座

PART NO:DC-006

DRAWING NO:9*8.5*5.5

DRAWN:

DATE:

18-10-08

UNIT:
mm

CHECKED:

DATE:

18-10-08

SCALE:
FULL

APPROVED:

DATE:

18-10-08

SIZE:
A4