

RoHS2.0  
Compliant

H	
4.3	4.5
5.0	5.5
6.0	6.5
7.0	7.5
8.0	8.5
9.0	9.5
10.0	

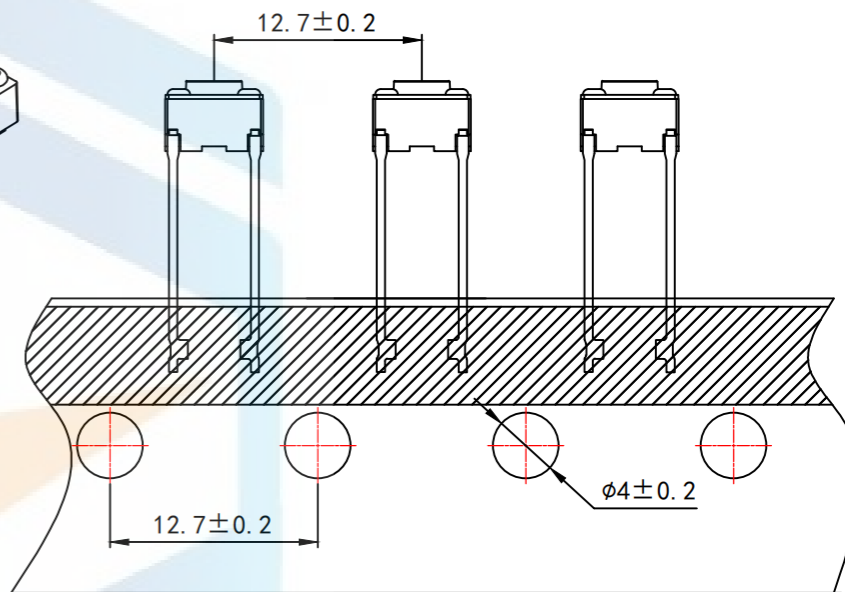
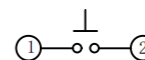
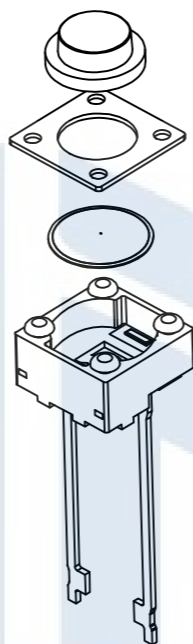
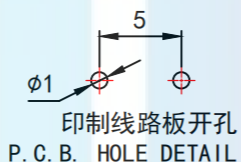
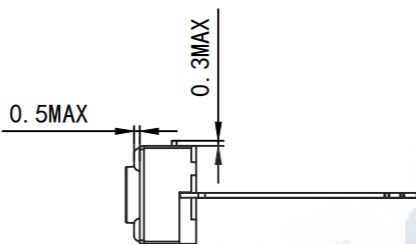
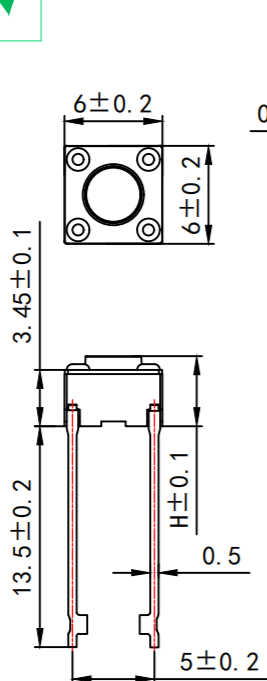

Key Technical Specifications:

1. Rating: 50mA DC12V
2. Contact resistance:  $\leq 50m\Omega$
3. Operating force:  $250 \pm 40gf$
4. Itinerary:  $0.25 \pm 0.1mm$
5. Insulation resistance:  $\geq 100M\Omega$
6. Electrical strength: 250V 50HZ 1Min.
7. life span: 100,000 Cycles

TOLERANCE

X. XXX	$\pm 0.05$
X. XX	$\pm 0.15$
X. X	$\pm 0.20$
X.	$\pm 0.30$
ANGLE	$\pm 5.0^\circ$

PROTECTON

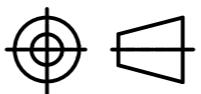

东莞市恒祺电子科技有限公司  
Dongguan Hengqi Electronic Technology Co., Ltd

<https://www.hq-dz.com>

phone: 15812872448

TITLE:  
轻触开关

PART NO: HQ-TS-D024

DRAWING NO: 6\*6\*H中两脚

DRAWN:

DATE: 18-10-08

UNIT:  
mm

CHECKED:

DATE: 18-10-08

SCALE:  
FULL

APPROVED:

DATE: 18-10-08

SIZE:  
A4